

Emitter Mechanical Dimensions

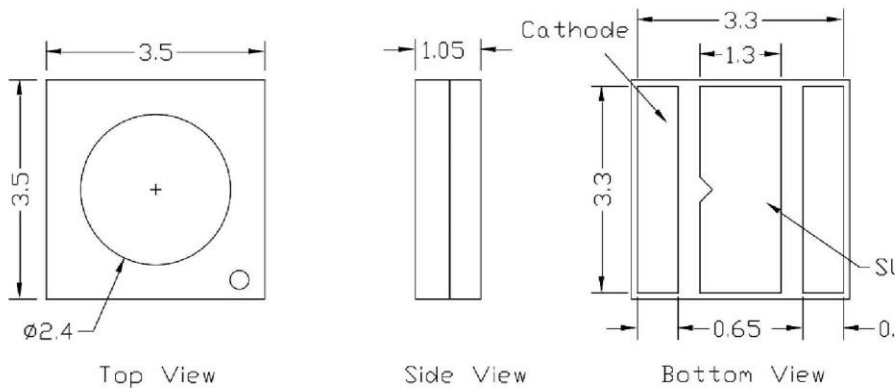

Circuit Diagram

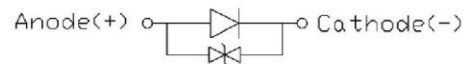

Flux Characteristics at 30mA, $T_j = 25^\circ\text{C}$

Radiation Pattern	Color	Part Number Emitter	Radiometric Power (mW)	
			Minimum	Typical
Lambertian	UV-C	PB2D-XXXX-XX		5.25

- ProLight maintains a tolerance of $\pm 10\%$ on flux and power measurements.
- Please do not drive at rated current more than 1 second without proper heat sink.

Absolute Maximum Ratings



Parameter	UV-C
DC Forward Current (mA)	30
ESD Sensitivity (HBM per MIL-STD-883E Method 3015.7)	$\pm 4000\text{V}$
LED Junction Temperature	90°C
Operating Board Temperature at Maximum DC Forward Current	$-40^\circ\text{C} - 60^\circ\text{C}$
Storage Temperature	$-40^\circ\text{C} - 85^\circ\text{C}$
Soldering Temperature	JEDEC-J-STD-020D
Allowable Reflow Cycles	3
Reverse Voltage	Not designed to be driven in reverse bias

Absolute Maximum Ratings

Parameter	UV-C
DC Forward Current (mA)	30
ESD Sensitivity (HBM per MIL-STD-883E Method 3015.7)	±4000V
LED Junction Temperature	90°C
Operating Board Temperature at Maximum DC Forward Current	-40°C - 60°C
Storage Temperature	-40°C - 85°C
Soldering Temperature	JEDEC-J-STD-020D
Allowable Reflow Cycles	3
Reverse Voltage	Not designed to be driven in reverse bias

Forward Current Characteristics, $T_j = 25^\circ\text{C}$

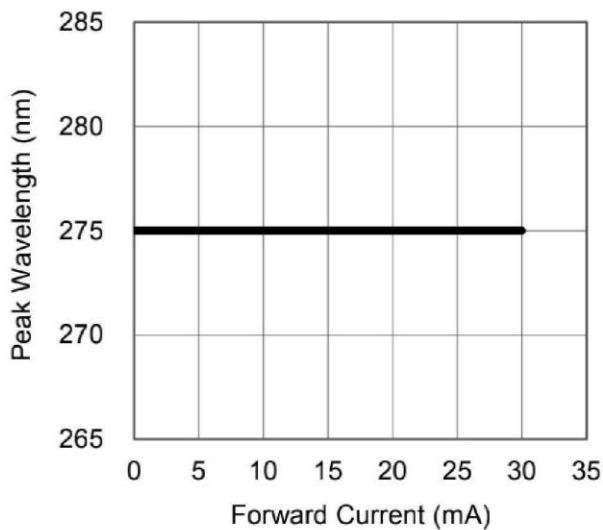

Fig 1. Forward Current vs. Peak Wavelength

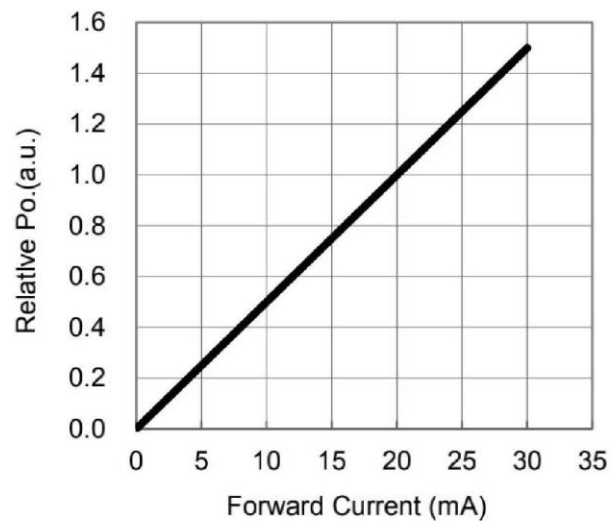

Fig 2. Forward Current vs. Relative Radiant Flux

Application notes:

1. Recommended current : 100mA

2. Moisture Proof Packing

- ✧ In order to prevent moisture absorption into SMT-LED during the transportation and storage, SMT-LED is packed in a moisture barrier bag. Desiccants and a humidity indicator are packed together with SMT-LED as the secondary protection. The indication of humidity indicator card provides the information of humidity within SMD packing. Humidity sensitive grade 2A

3. Storage

- ✧ Shelf life in original sealed bag at storage condition of $<40^{\circ}\text{C}$ and $<90\%RH$ is 12 months. Baking is required whenever shelf life is expired.
- ✧ Before unpacking, please check whether there is air leak in the packing bag. After bag opening, the SMT-LED must be stored under the condition $<30^{\circ}\text{C}$ and $<60\%RH$. Under this condition, SMT-LED must be used (subject to reflow) within 24 hours after bag opening, and re-baking is required when exceeding 24 hours.
- ✧ For baking, place SMT-LED in oven at temperature $80^{\circ}\text{C}\pm 5^{\circ}\text{C}$ and relative humidity $\leq 10\%RH$, for 24 hours.

4. Cleaning

- ✧ Don't use unspecified chemical liquids to clean the SMT-LED; the chemical could harm the SMT-LED. When washing is necessary, please immerse the SMT-LED in alcohol at normal room temperature for less than 1 minute and dry at normal room temperature for 15 minutes before use.
- ✧ The influence of ultrasonic cleaning on the SMT-LED depending on factors such as ultrasonic power and the way SMT-LED are mounted. Ultrasonic cleaning shall be pre-qualified to ensure this will not cause damage to the SMT-LED.

5. Electrostatic Discharge and Surge current

- ✧ Electrostatic discharge (ESD) or surge current (EOS) may damage SMT-LED.
- ✧ Precautions such as ESD wrist strap, ESD shoe strap or antistatic gloves must be worn whenever handling of SMT-LED.
- ✧ All devices, equipment and machinery must be properly grounded.
- ✧ It is recommended to perform electrical test to screen out ESD failures at final inspection.
- ✧ It is important to eliminate the possibility of surge current during circuitry design

6. Heat Management

- ✧ Heat management of SMT-LED must be taken into consideration during the design stage of SMT-LED application. The current should be de-rated appropriately by referring to the de-rating curve attached on each product specification.

7. Soldering

• Manual soldering by soldering iron :

- ✧ The use of a soldering iron of less than 25W is recommended and the temperature of the iron must be kept at below 315°C , with soldering time within 3 seconds.
- ✧ The epoxy resin of SMT-LED should not be in contact with tip of soldering iron.
- ✧ No mechanical stress should be exerted on the resin portion of SMT-LED during soldering.
- ✧ Handling of SMT-LED should be done when the package has been cooled down to below 40°C or less. This is to prevent the SMT-LED failures due to thermal-mechanical stress during handling

8. Repair

LED Should not be repaired in reflow , When repair is inevitable , a double-head soldering iron should be used .It should be confirmed in advance whether the characteristics of LEDs will or will not be damaged by repairing ;

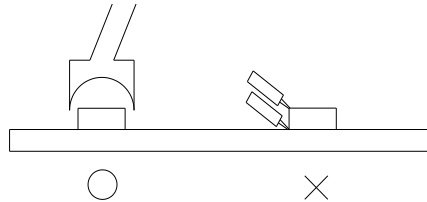

Cautions :

The encapsulated material of the LEDs is silicone. Therefore the LEDs have a soft surface on the top of package. The pressure to the top surface will be influence to the reliability of the LEDs. Precautions should be taken to avoid the strong pressure on the encapsulated part. So when use the picking up nozzle, the pressure on the silicone resin should be proper.

9. Handling precautions

- Compare to epoxy encapsulant that is hard and brittle, silicone is softer and flexible. Although its characteristic significantly reduces thermal stress, it is more prone to damage by external mechanical force . As a result, Special handling precautions must be observed during assembling using silicone encapsulated LED products, Failure to comply might leads to damage and premature failure of the LED.

9-1.Handle the component along the side surface by using forceps or appropriate tools; do not directly touch or Handle the silicone lens surface, it may damage the internal circuitry

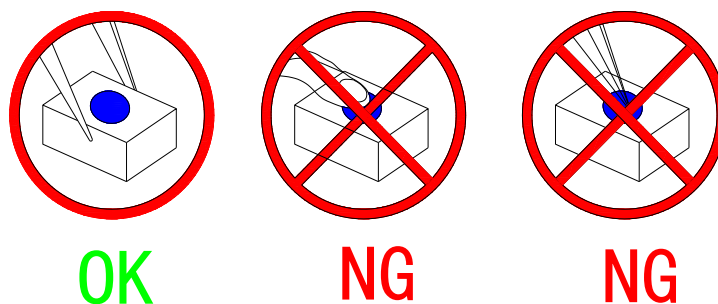

9-2.The outer diameter of the SMD pickup nozzle should not exceed the size of the LED to prevent air leaks. The inner diameter of the nozzle should be as large as possible. A pliable material is suggested for the nozzle tip to avoid scratching or damaging the LED surface during pickup. The dimensions of the component must be accurately programmed in the pick-and-place machine to insure precise pickup and avoid damage during production.

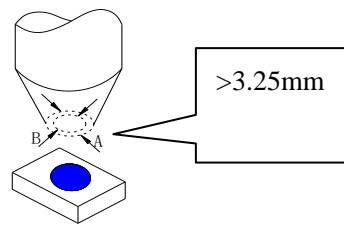

9-3. Do not stack together assembled PCBs containing LEDs. Impact may scratch the silicone lens or damage the internal circuitry

9-4. Not suitable to operate in acidic environment, $\text{PH}<7$

9-5. LED operating environment and sulfur element composition cannot be over 100PPM in the LED mating usage material

9-6. When we need to use external glue for LED application products, please make sure that the external glue matches the LED packaging glue. Additionally, as most of LED packaging glue is silica gel, and it has strong Oxygen permeability as well as strong moisture permeability; in order to prevent external material from getting into the inside of LED, which may cause the malfunction of LED, the single content of Bromine element is required to be less than 900PPM, the single content of Chlorine element is required to be less than 900PPM, the total content of Bromine element and Chlorine element in the external glue of the application products is required to be less than 1500PPM

9-7. When we need to use external glue for LED application products, we need to control the over temperature under 55°C , As we mentioned at 9-6, the external glue contain Chlorine element, it can destroy the led.

● SMT Reflow Soldering Instructions

Suggested Welding Temperature Curve :

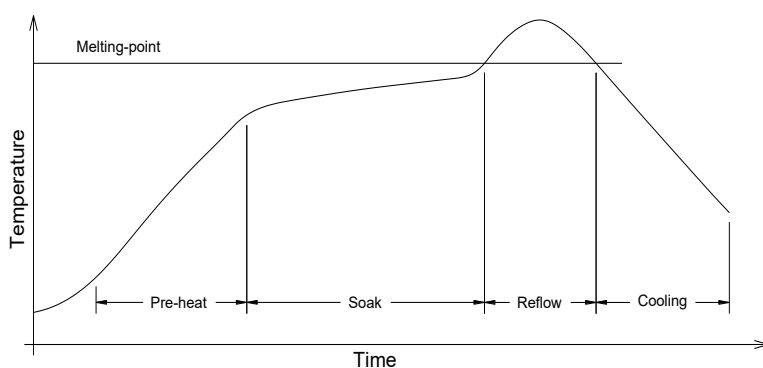

solder (Sn63/Pb37)	solder(Sn/Bi/Ag)
Peak rise average speed:4°C/s	Peak rise average speed:最快 3°C/s
preheat temperature:100~150°C	preheat temperature:130~170°C
preheating time:less than 100 秒	preheating time:less than100 秒
Peak descent average speed: 6°C/s	Peak descent average speed: 6°C/s
Crest temperature:240°C	Crest temperature:255°C
The time at the top of the wave at 5 degrees:10 秒	The time at the top of the wave at 3 degrees:10 秒
The maximum duration is 80 seconds at 183 degrees centigrade	The maximum duration is 40 seconds at 200 degrees centigrade

- ✧ Repair is not recommended when soldering is completed.Repair soldering is unavoidable , it must be checked and accepted after repairing,Preventing repair Destroy LEDs
- ✧ Reflow soldering should not be done more than two times ;
- ✧ When soldering , do not put stress on the LEDs during heating ;
- ✧ After welding, PCB can not be wrapped immediately, we should let the PCB board and the SMD-LED products cooling natural state.